

VT591 / Water leak rope sensor

Function and purpose

i Notice on 6th June 2019: The product has been altered. RJ9 4P2C connected is now used instead of 2P Power Terminal.



The sensor must be used together with



or



When water is in contact with the detection cable sensor indicates the emergence of moisture. "WDC / Water detection rope" and "WLC / Water leakage cable" are ordered separately! The whole area can be effectively monitored by placing the cable near or along with possible flood sources.

Dimensions

Usage examples

Perimeter leakage detection using

"VT591 / Water leak sensor"
"WDC / Water detection rope" or "WLC / Water leak cable"
and Vutlan monitoring system

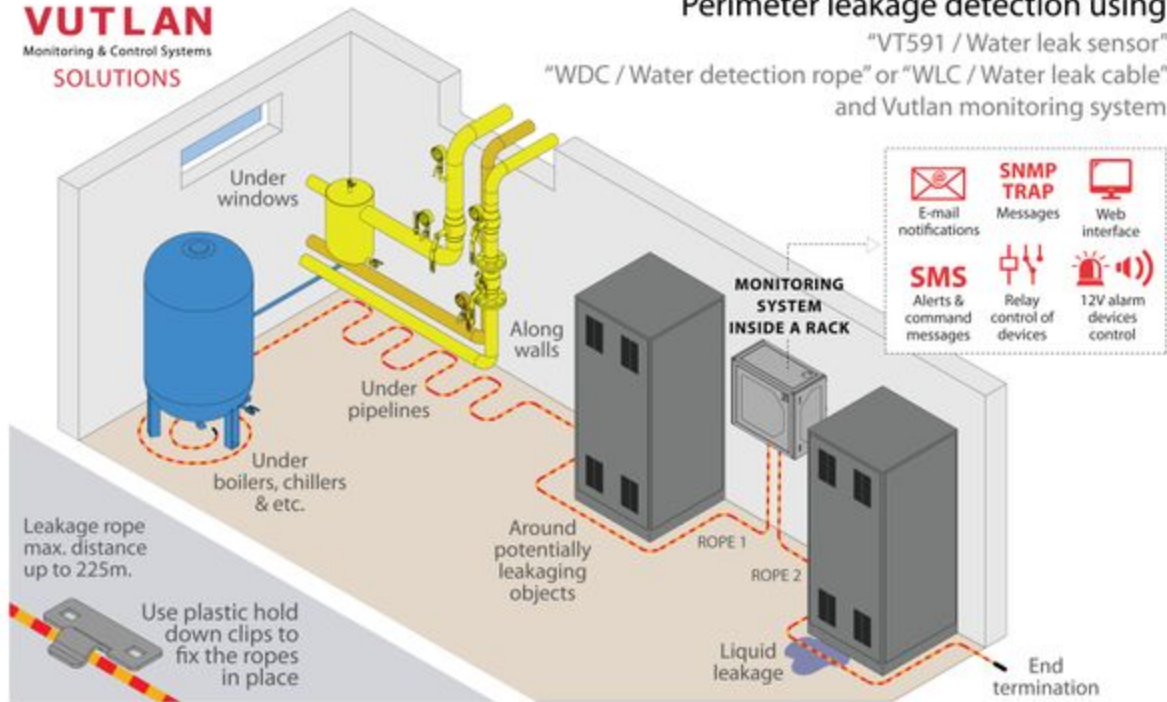

Leakage detection under the raised floor in IT facilities & offices.

"VT591 / Water leak rope sensor" +
"WDC / Water detection rope" or
"WLC / Water leak cable" +
Vutlan monitoring unit

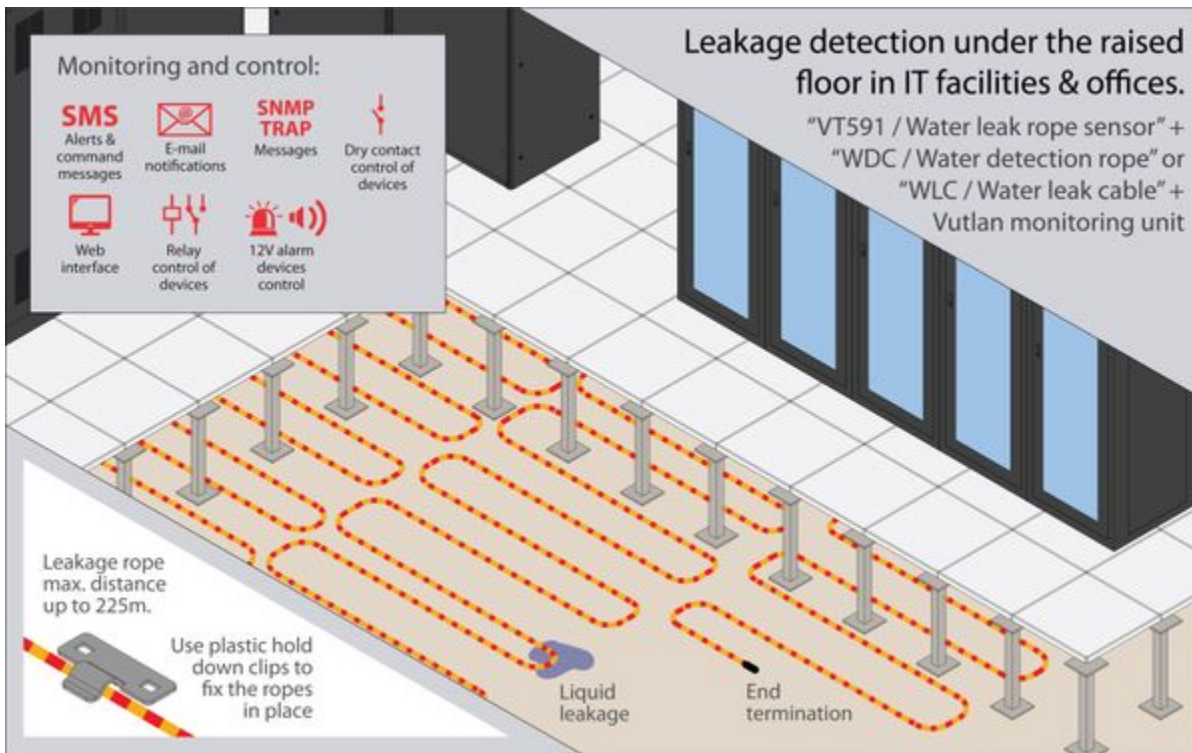

Multiple spots leakage detection

VT591 / Water leak sensor +
 "WLC / Water leak rope" or "WDC / Water detection rope" +
 Vutlan monitoring system

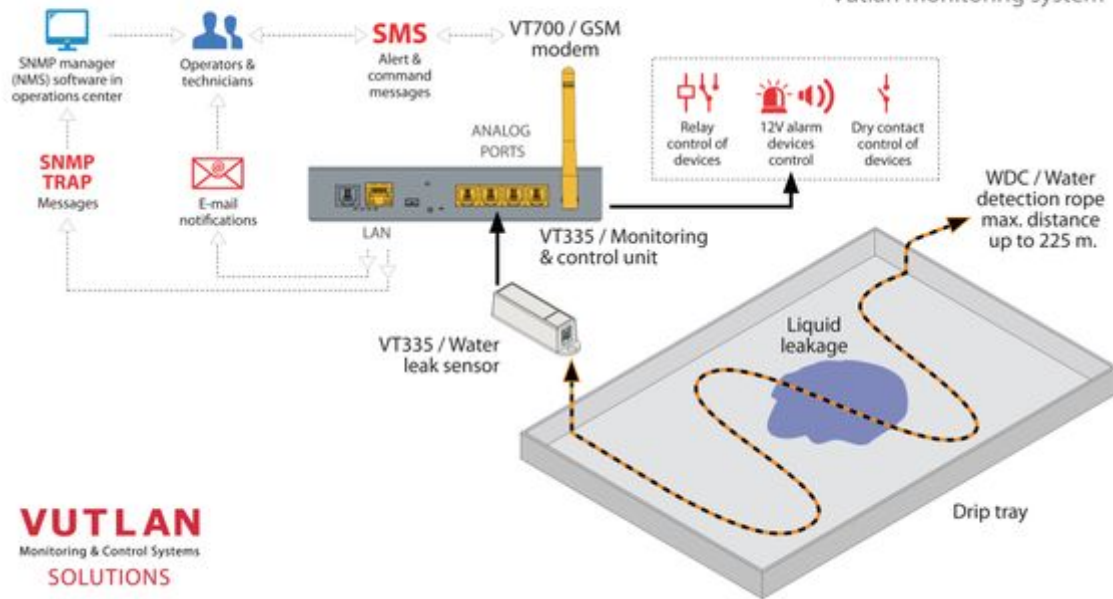

VUTLAN
 Monitoring & Control Systems
 SOLUTIONS

Technical specifications

VT591 / Water leak sensor specifications	
Dimensions	60×18×18 mm
Weight	60 g
Input	2 wire (WDC cable)
Output	RJ11 / RJ12 (6p4c)
Operating temperature	-10 °C to +80 °C
Operating humidity	5% to 95% (Non-Condensing)
Mounting	Mounting bracket included.
Power consumption	60mW
Max. distance m	100 m
HS Code	9025 80 400
Components	Manufactured in E.U.
Special features	Response time: 15 sec., Recovery time: Depends on how fast the sensor dries out

WDC / Water detection rope specifications	
Description	WDC can detect moisture (works until the dew point) and does not welcome pollution!
Detectable liquids	Clean, polluted & distilled water; acids; alkalis; alcohols, and other electrically conductive liquid
Diameter	3 mm in diameter
Lengths	Order options include 6m, 10m, 17m, 25m, 50m, or custom length.
Weight	15 g/m

Operating temperature	Min. -50° C, Max. 105° C
Max. rope length	225 m
Conductor	27% Ni

WLC / Water leak cable specifications



Description	WLC can work in high humidity, pollution, and hazardous waste
Detectable liquids	Clean, polluted & distilled water; acids; alkalis; alcohols, and other electrically conductive liquid
Diameter	5.5 mm in diameter
Lengths	Order options include 10m, 15m, 25m, 50m, or custom length.
Weight	26 g/m
Operating humidity	0° - 100 %
Max. cable length	225 m
Inputs	x2 wires

Package content

i VT591, WDC and WLC are sold separately.

- [VT591 package includes:](#)
- [WDC / Water detection rope package includes:](#)
- [WLC / Water leak cable package includes:](#)



VT591 package includes:

Package content	Description
	Sensor
	Telephone cable 2m
	Screw 4,2*16

	
	Bolts M3.5x10 - 2 pcs
	M3.5 nuts - 2 pcs
	Sticker
	Flood adapter cable

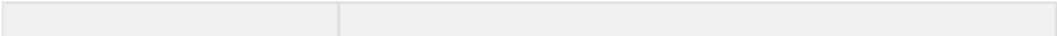
WDC / Water detection rope package includes:



Package content	Description
	<p>WDC6 or WDC10 or WDC17 or WDC25 or WDC50 leakage cable</p>
	<p>Sticky hold-down clips for each 2 m of the rope.</p>

WLC / Water leak cable package includes:

Package content	Description
	<p>WLC10 or WLC15 or WLC25 or WLC50 leakage cable</p>
	<p>Sticky hold-down clips for each 2 m of the rope.</p>
	<p>Protective cap</p>

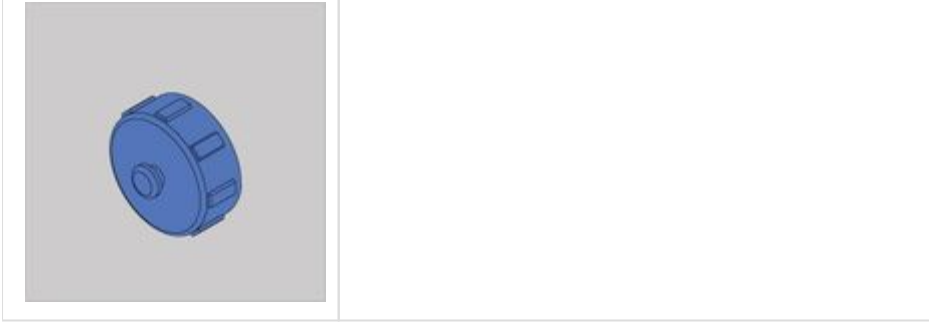

Connecting WDC / Water detection rope

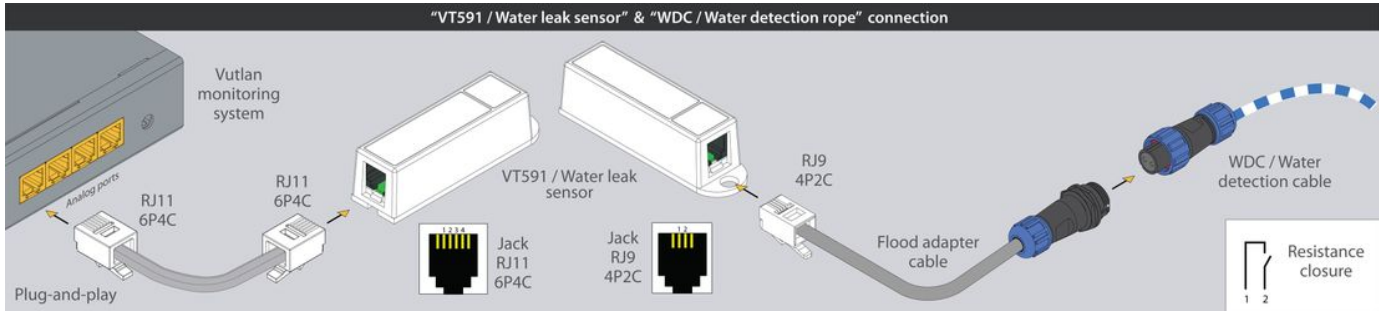

1. Connect the WDC rope sensor to the VT591 leak sensor.
2. Wire the WDC rope around or under potentially leaking objects around the perimeter or under raised floors.
3. Connect the sensor to the monitoring unit. The connection is plug-an-play.
4. The sensor is ready to use.

Connecting WLC / Water leak cable

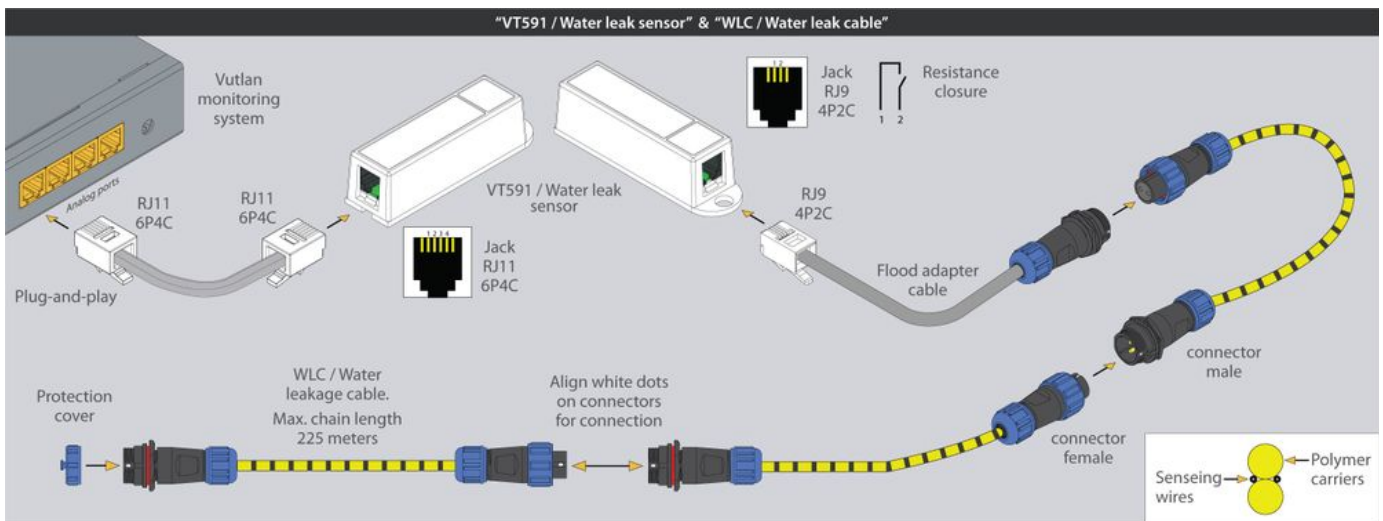

1. Connect the "VT591 / Water leak sensor" to the monitoring unit. The connection is plug-an-play.
2. Connect "VTC / Terminal cable" to the VT591 sensor.
3. Connect "WLC / Water detection cable" to "VTC / Terminal cable".
4. Connect any additional "WLC / Water detection cables" to each other as shown in the picture above to make a chain connection.
5. Wire the WLC rope around or under potentially leaking objects around the perimeter or under raised floors.
6. Put a protective cap on the connector of the last WLC cable in a chain.
7. The sensor is ready to use.

Analog sensor connection

Analog sensors connection

Connect the analog sensor by a supplied RJ-11 (6P4C) cable to any analog port "A1 .. A8" or "Sensor" port. The determination of the sensor type and connection will occur automatically.

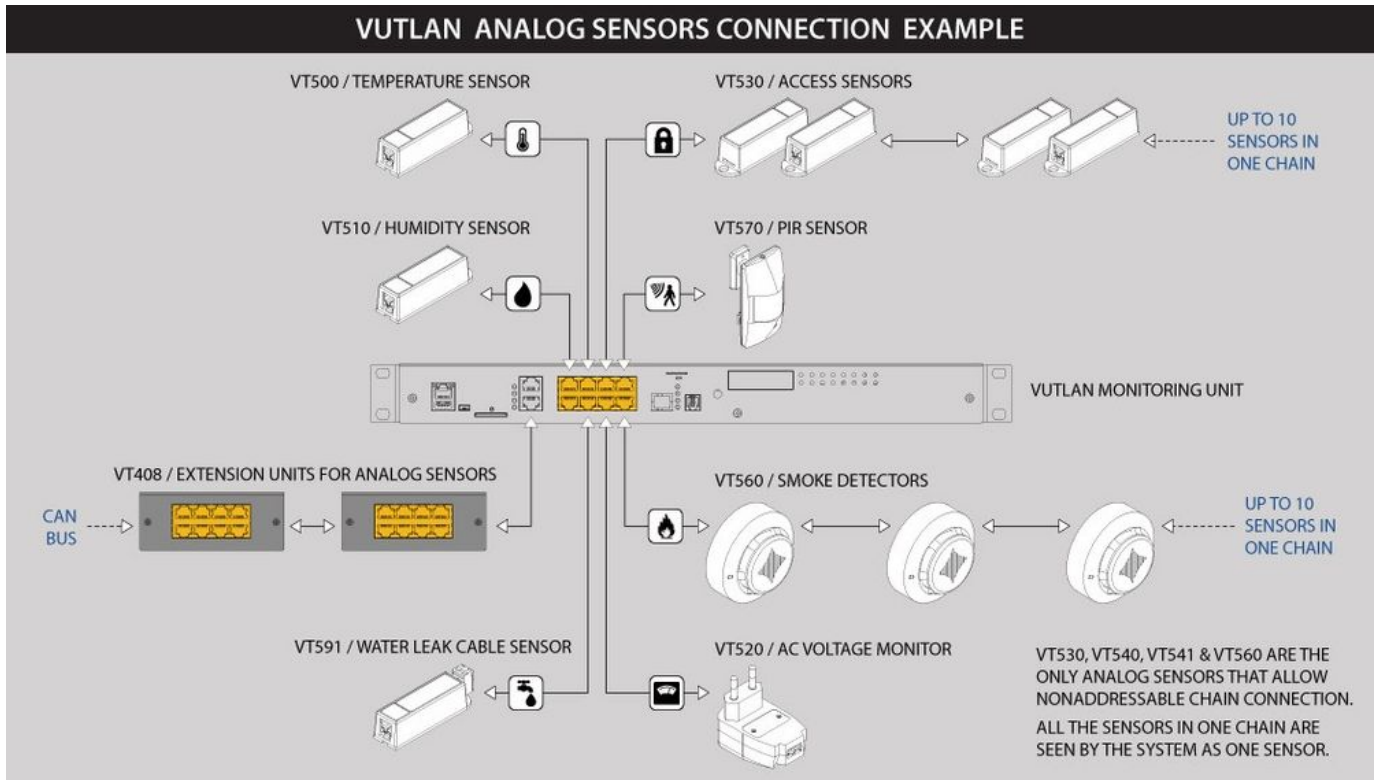

⚠ If strong electromagnetic interference is present, we recommend using 3-pair cable CAN FTP for sensor connection!

6P4C RJ11 cable wiring / pinouts



1- Yellow, 2- Green, 3- Red, 4 - Black

Colors are true for this telephone cable. Both ends match the colors and pinouts (identical).

Please refer to the RJ connectors comparison table:

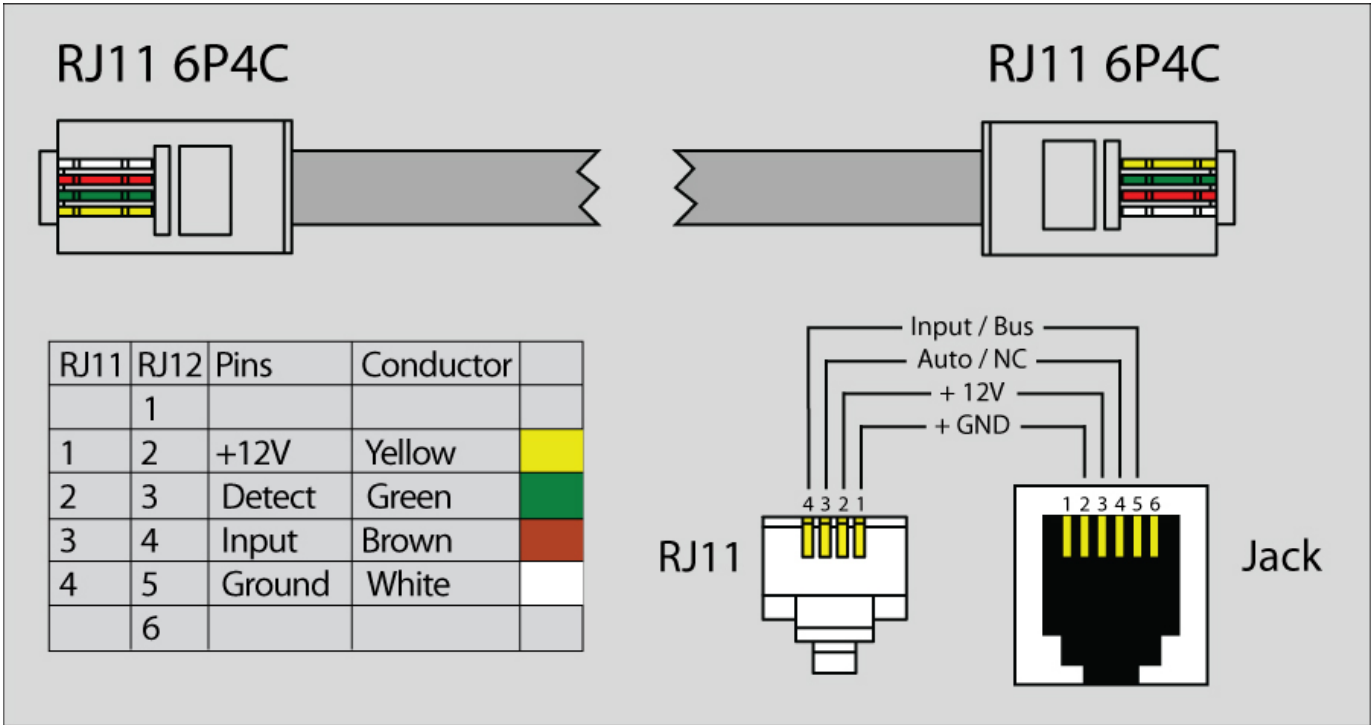

Daisy chain connection

Some of the analog sensors can be connected in a daisy chain. Please refer to the article "[Chain connection of analog sensors](#)".

Extending the number of analog sensors

The device does not contain any user-serviceable parts. If the power meter requires service, contact your local sales representative. Do not open the device. Opening the device voids the warranty.

Troubleshooting

The following table describes potential problems and their possible causes. It also describes checks you can perform or possible solutions for each. After referring to this table, if you cannot resolve the problem, contact your local Vutlan sales representative for assistance.

Potential Problem	Possible Cause	Possible Solution
The data being displayed is inaccurate or not what you expect.	Incorrect setup values.	Check that You use the correct $f(x)$ formula
	Incorrect voltage inputs.	Check power meter voltage input terminals to verify that adequate voltage is present
	The power meter is wired improperly.	Check that all wires are connected correctly and that they are energized. See "Wiring Diagrams" of the device.
The sensor does not appear in the Vutlan monitoring interface	Communication lines are improperly connected.	Check 6P4C RJ11 communication cable.
	The communication cable is inserted into the wrong port.	6P4C RJ11 communication cable must be inserted into the analog port of the Vutlan monitoring system.

Copyright:

Vutlan s.r.o. (LLC)

Remote Infrastructure Monitoring and Control

43 ul.Svornosti, 821 06 Bratislava,

Slovak Republic

www.vutlan.com